

Număr model :
2312-864-84

Typ:
864

ESENA

1D1W

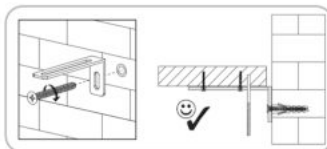
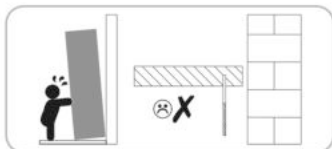
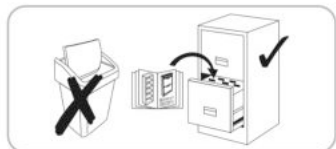
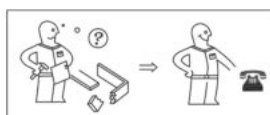
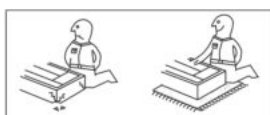
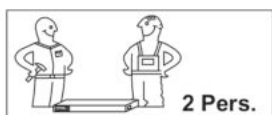

Ø5
Ø8

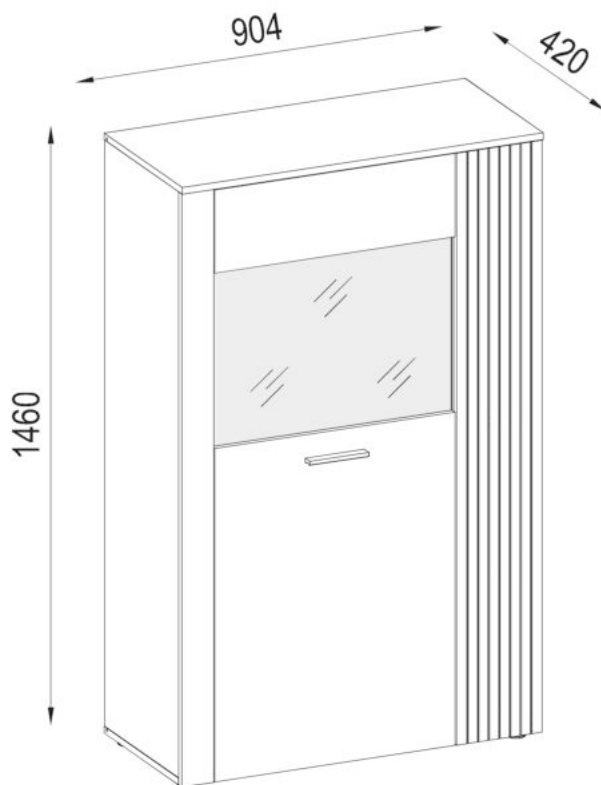
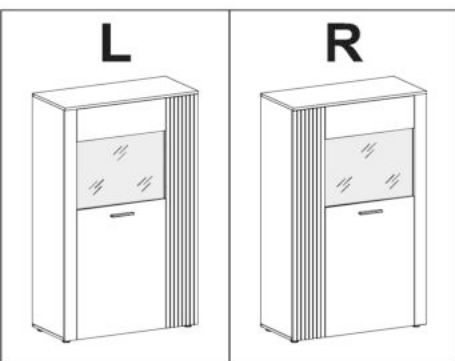

strângere



introducere prin apăsare



măsurare



apăsare



introducere prin bătaie



Întoarceți - roțiți

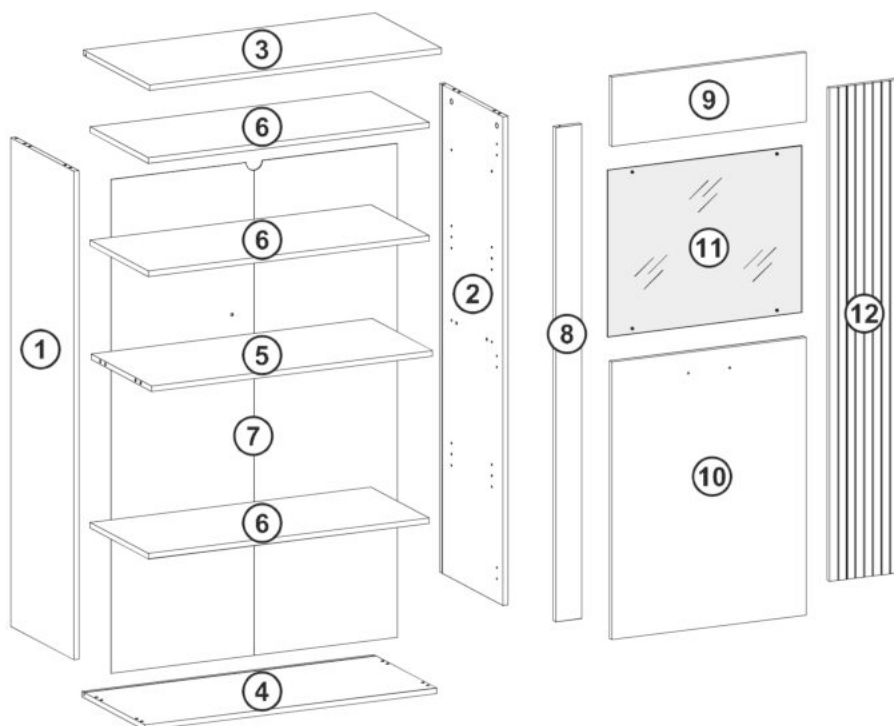







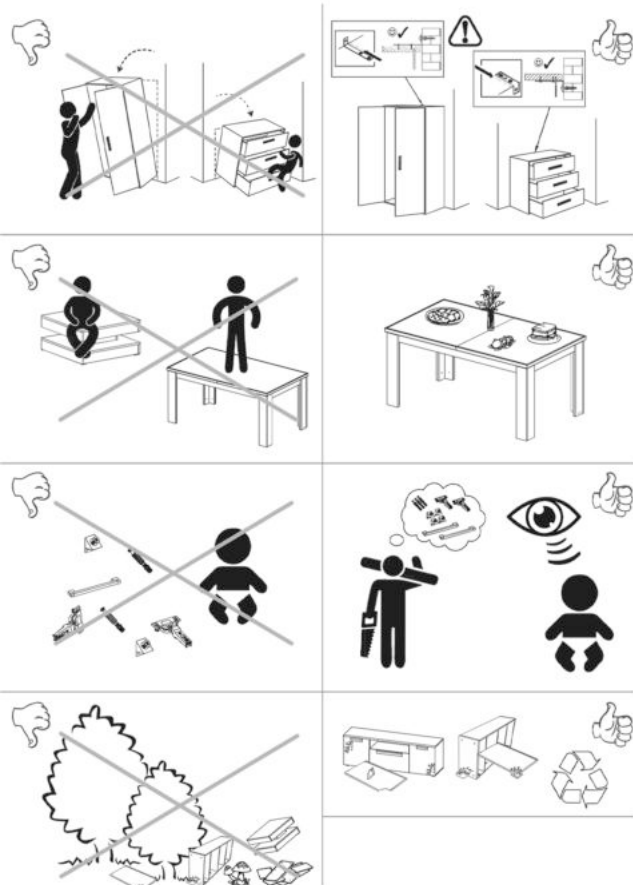







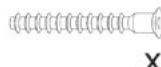









A	B (mm)		C	D
1	1408	400	16	x1 2/2
2	1408	400	16	x1 2/2
3	904	420	16	x1 1/2
4	904	400	16	x1 1/2
5	870	384	16	x1 1/2
6	870	370	16	x3 1/2
7	1423	886	2,5	x1 2/2

A	B (mm)		C	D
8	1424	80	18	x1 2/2
9	200	604	16	x1 2/2
10	800	604	16	x1 2/2
11	602	481	4	x1 2/2
12	1421	214	16	x1 2/2

B1				1/2
----	--	--	--	-----



B1 1/2

A1 15x12  x8	C2 44mm  x8	B2 8x30  x12
FA1 4mm  x1	F3 6,3x50  x4	O3 Ø18  x4
K6 Ø35  x3	J65 128/148  x1	O4 Ø18  x4
M1 10x10x15  x12	P14 45x20  x4	N1 Ø6  x12
Y36 75x32x15  x1	N5 10x6x10  x4	DB2 4x25  x2
D25 4x25  x4	Y37 8x50  x1	Y35 4,2x65  x1
DA21 4,2x16  x18	D11 3,5x16  x14	R10 Ø10  x4
T1 30x35x55  x3	K9 Ø35  x3	O5 Ø8  x2
O6 40x40x14  x3		

Stimată clientă, stimat client, îți mulțumim pentru achiziția unei piese de mobilier din programul nostru de interior pentru utilizarea exclusivă în încăperi private. Vă rugăm să verificați integritatea volumului livrării și să citiți cu atenție informațiile importante de mai jos înaintea montajului și să le păstrați pentru utilizarea ulterioară, inclusiv de către terți. Piesele noastre de mobilier trebuie să fie folosite conform destinației. Utilizarea neconformă destinației poate cauza daune materiale sau în anumite circumstanțe vătămări corporale. Piesele de mobilier nu sunt jucării. Producătorul sau comerciantul nu își asumă răspunderea pentru daune, care sunt provocate prin utilizarea neconformă destinației sau prin manipularea greșită.

ATENȚIE: Copiii și persoanele cu handicap psihic trebuie să fie ținute întotdeauna la distanță față de piese de mobilier, obiecte ascuțite, piese mici și materiale de ambalaj, există pericolul de vătămare și/sau asfixiere.

MONTAJ: Pentru montaj, vă rugăm să vă orientați după instrucțiunile noastre de funcționare, de operare, de instalare sau de montaj și să respectați în special avertismentele și indicațiile de siguranță. Dacă instrucțiunile nu au fost respectate, acest fapt poate să provoace leziuni la persoane sau daune la mobilier / pot să devină un risc de siguranță. Dacă aveți dificultăți la asamblare / montaj, vă rugăm să contactați echipa noastră de service. Aceasta vă stă alături cu sfaturi și asistență. Montajul poate fi efectuat numai de către persoane calificate. În cazul modificărilor la produs/piese ale produsului, în cazul schimbării, respectiv al înlocuirii pieselor / materialelor de consum, care nu provin de la producător/comerciant, nu se poate prelua nicio răspundere pentru daune.

Dacă marfa include mijloace de montare pe perete, precum dibluri și șuruburi, acestea sunt destinate exclusiv pentru utilizarea la pereți din materiale masive și unitare. O fixare este numai așa de bună ca legătura dintre mijlocul de fixare și perete. Vă rugăm să verificați atât în cazul pieselor de mobilier de sine stătătoare cât și al celor suspendate, înainte de fixarea lor, perețele dumneavoastră cu privire la adecvarea în acest sens și utilizați numai mijloacele de montare adecvate. Înaintea eventualelor lucrări de găurire, asigurați-vă că nu se află cabluri în zona de găurire. În final, montatorul este responsabil pentru fixarea sigură de perete. Aceasta privește și instalarea articolelor electrice, precum și celelalte accesorii tehnice constructive. Montarea / instalarea articolelor electrice, precum și a altor accesorii relevante constructiv trebuie să fie efectuate numai de personal calificat autorizat. Toate instalațiile electrice, precum și tehnice constructive trebuie să fie executate conform standardelor respective valabile, respectiv normelor de siguranță din țara dumneavoastră. Pentru sursele de lumină vă rugăm să folosiți numai intensitățile admisibile ale corpurilor de iluminat. În cazul nerespectării numărului max. de Watt există pericol de incendiu din cauza supraîncălzirii. Trebuie să se omită acoperirea corpului de iluminat din cauza pericolului de incendiu. O funcționare perfectă a mobilierului este garantată numai în cazul unei amplasări verticale și orizontale. Ușile sunt ajustate în prealabil, însă trebuie eventual aliniată / reglate din nou din cauza condițiilor locale. Vă rugăm să respectați neapărat indicațiile de greutate privind sarcina maximă. Nu este permis să urcați pe mobilă. În cazul utilizării necorespunzătoare, poate să apară răsturnarea pieselor de mobilier. Pentru a preveni acest fapt, piesele de mobilier ar trebui asigurate întotdeauna împotriva răsturnării. În cazul suprasarcinilor/supraîncălzărilor (în special prin copii care se joacă, oameni, materiale sau alte acțiuni necorespunzătoare) există pericolul de rupere și leziune. Toate șuruburile, precum și punctele de îmbinare portante ar trebui strănse din nou după 5 până la 6 săptămâni, pentru a asigura o stabilitate permanentă.

ÎNGRIJIRE:-Indicații de îngrijire a mobilei- Vă rugăm să respectați indicațiile noastre cu privire la îngrijirea corectă a mobilei, astfel încât să vă bucurați cât de mult posibil de produsul nostru.

Pentru curățare, utilizați o lavetă de bumbac curată, uscată și moale. Dacă mobilierul dumneavoastră necesită o curățare temeinică, puteți să umeziți laveta cu puțină apă sau soluție de curățare a mobilei și apoi să uscați elementele curățate. Cel mai bine curățați piesele din metal și sticlă cu soluții de curățare a metalului și a sticlei uzuale din comerț conform instrucțiunilor de îngrijire de pe acestea. Soluțiile de curățare trebuie să poarte o indicație clară că sunt adecvate pentru îngrijirea mobilei. În niciun caz nu folosiți aparate de curățare cu abur, precum și substanțe caustice, abrazive sau alte substanțe al căror efect nu îl cunoașteți.



ATENȚIE: Suprafețele lucioase sunt protejate printr-foleie la livrare. Lăsați-o pe mobilă, până când este montată complet și curățată de praf. Elementele lucioase, de pe care s-a îndepărtat folia de protecție pot fi curățate și folosite abia după 72 ore (timp pentru întărire ulterioară la aerul din încăpere). Nu deteriorați suprafețele cu obiecte ascuțite și în niciun caz nu le expuneți radiației solare puternice.

ELIMINARE -Indicații privind eliminarea deșeurilor- De dragul mediului înconjurător, vă rugăm să eliminați deșeurile de ambalaj pe sortimente în tomberoanele de deșeur/reciclare prevăzute în acest scop și nu în natură. Piese de mobilier deteriorate sau inutilizabile pot fi predate la centre de reciclare speciale în scopul reciclării pieselor individuale. Piese de mobilier scoase din uz, dar încă funcționale nu trebuie eliminate imediat. Donați-le, de exemplu, la organizații caritabile.

Sperăm să vă bucurați de noul dumneavoastră mobilier.

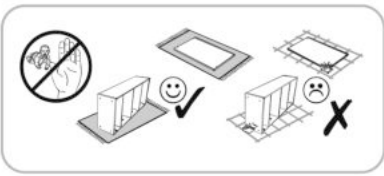
1



- A1** 15x12  x4
- C2** 44mm  x4
- B2** 8x30  x8

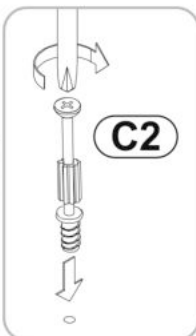
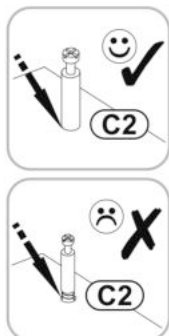
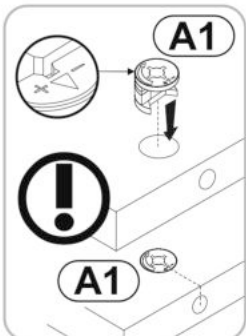
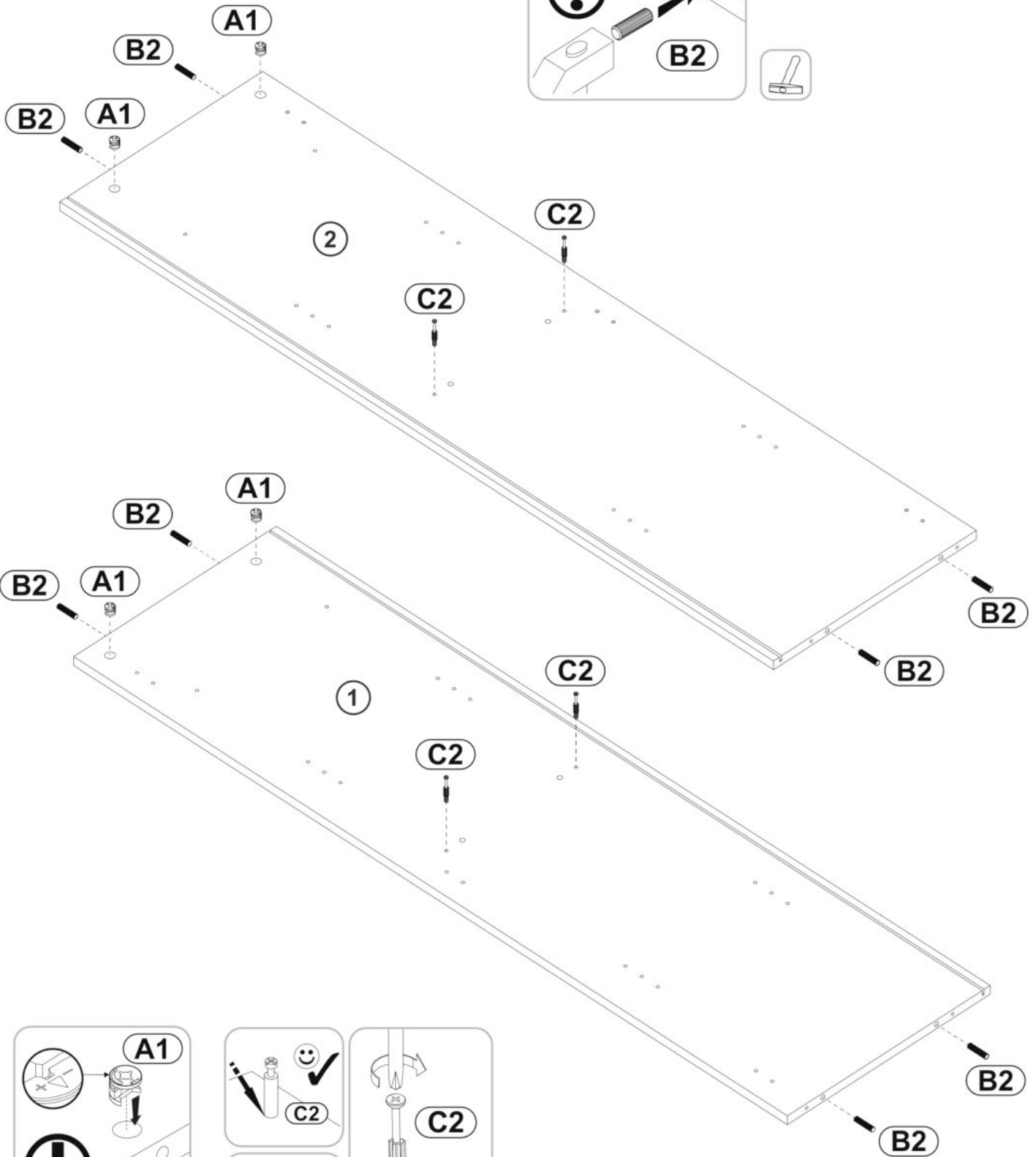
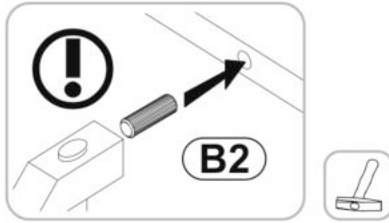

2

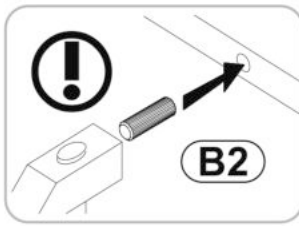
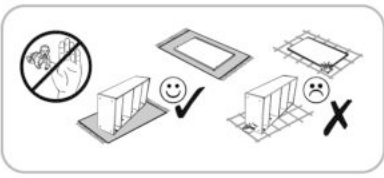

A1		x4
15x12		
C2		x4
44mm		
B2		x4
8x30		
Y36		x1
75x32x15		
D11		x2
3,5x16		

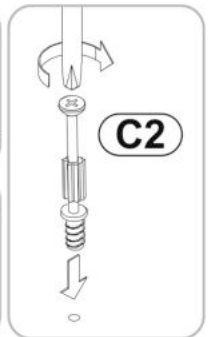
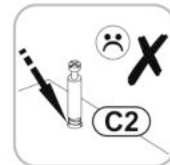
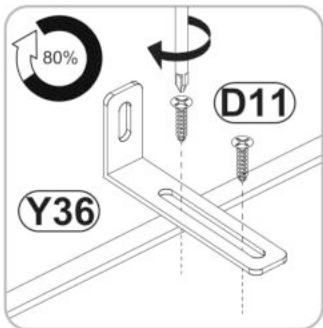
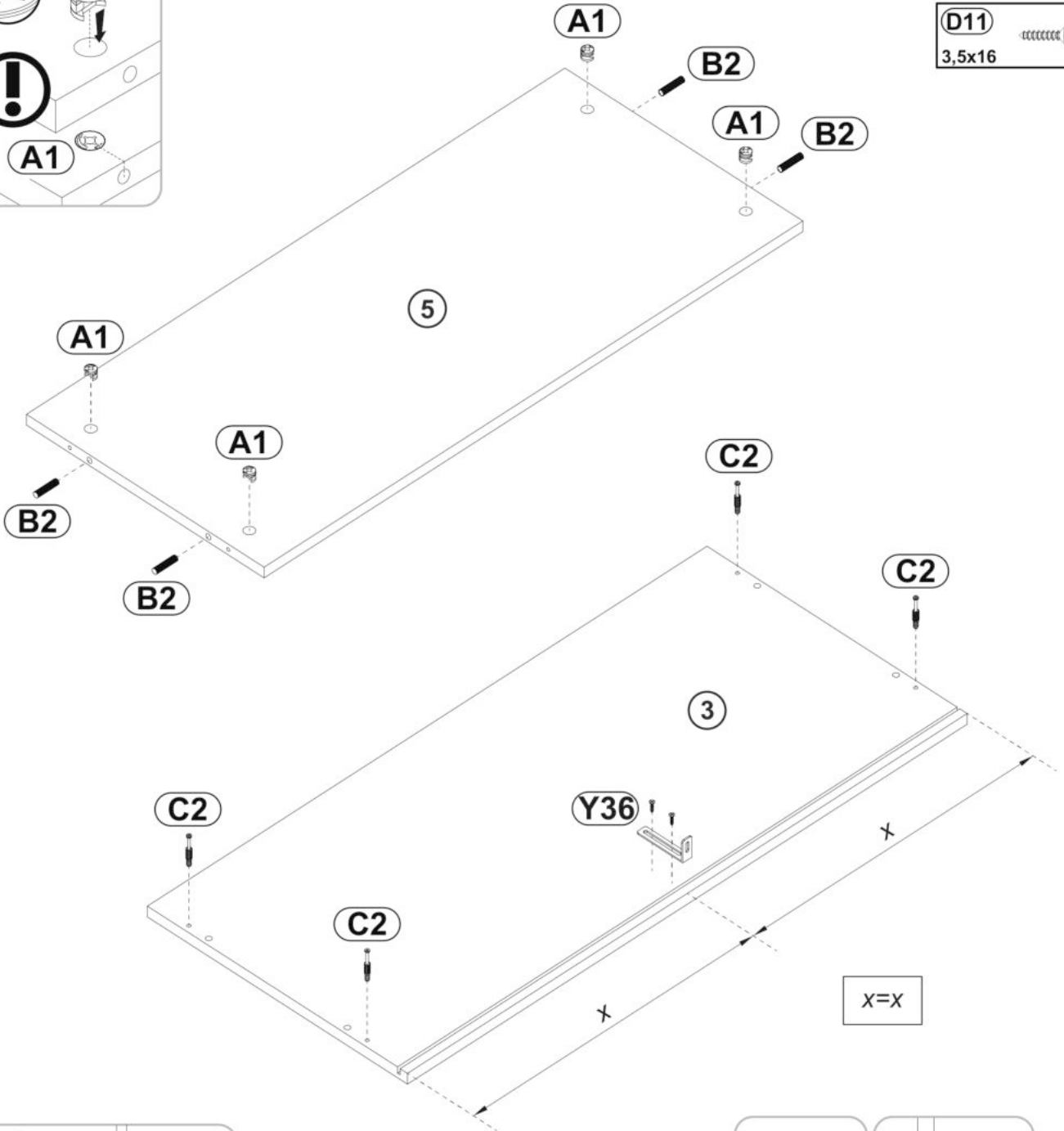
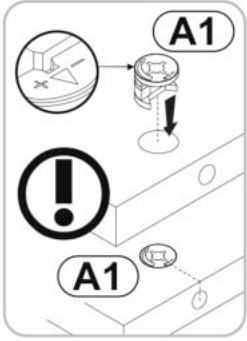

3

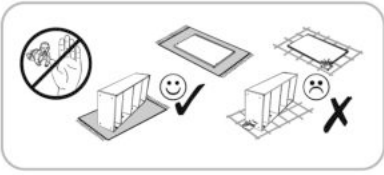

DA21
4,2x16  x6

T1
30x35x55  x3

K9
Ø35  x3

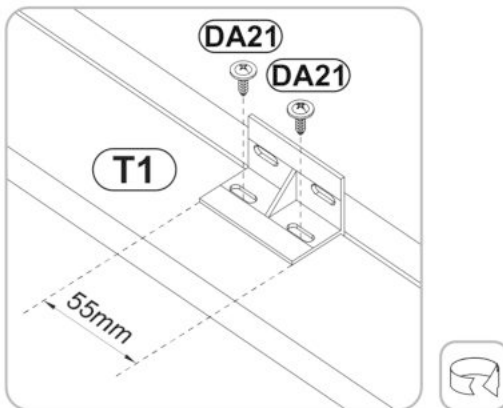
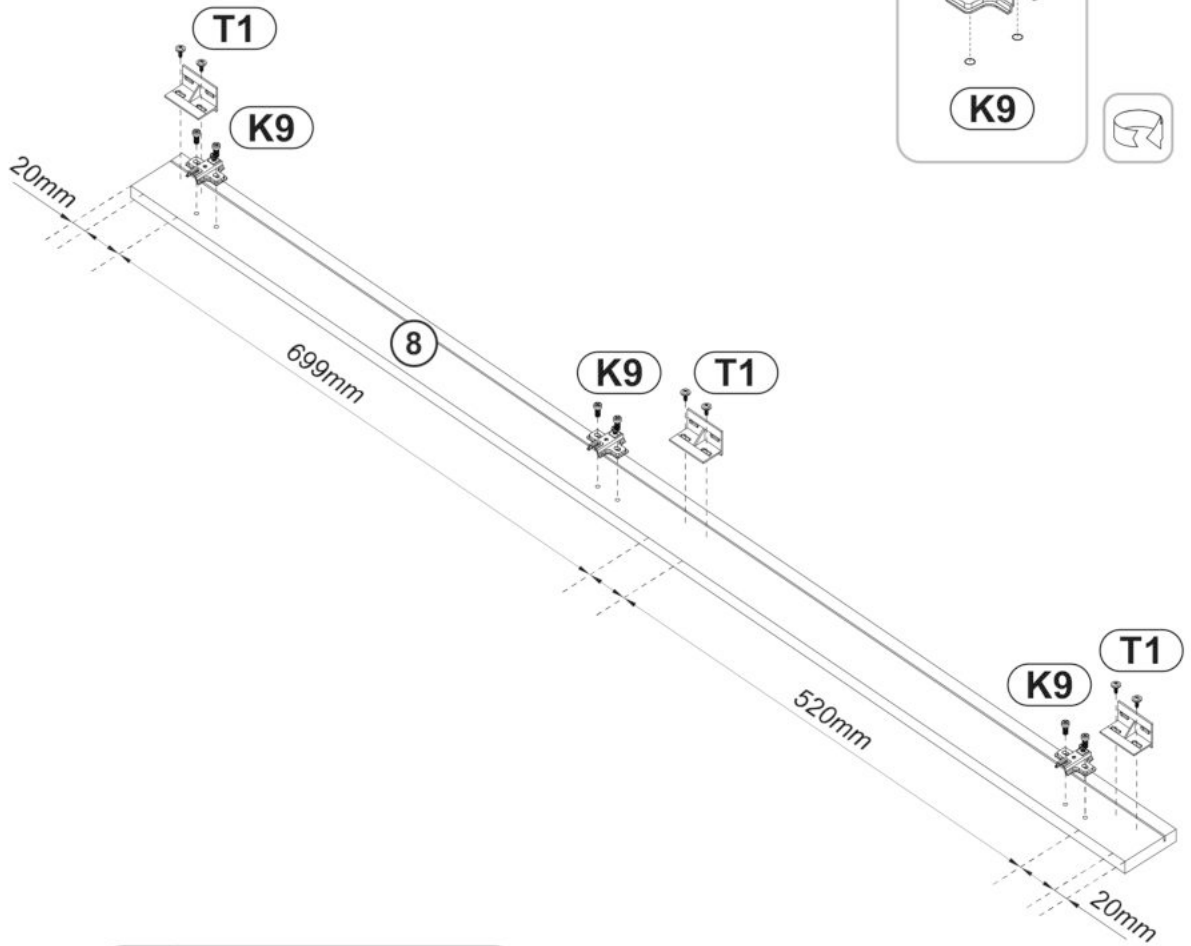
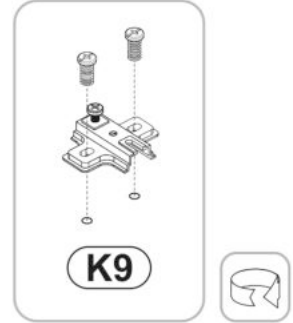
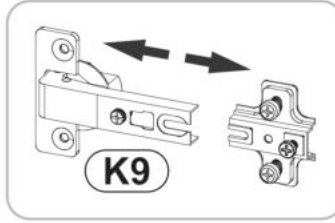

4

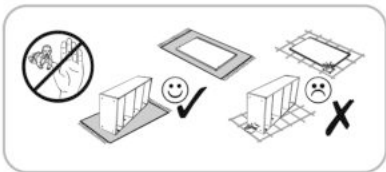

O3
Ø18  **x4**

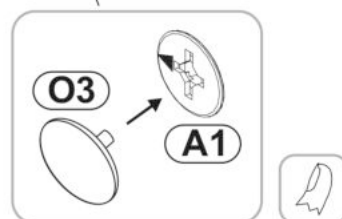
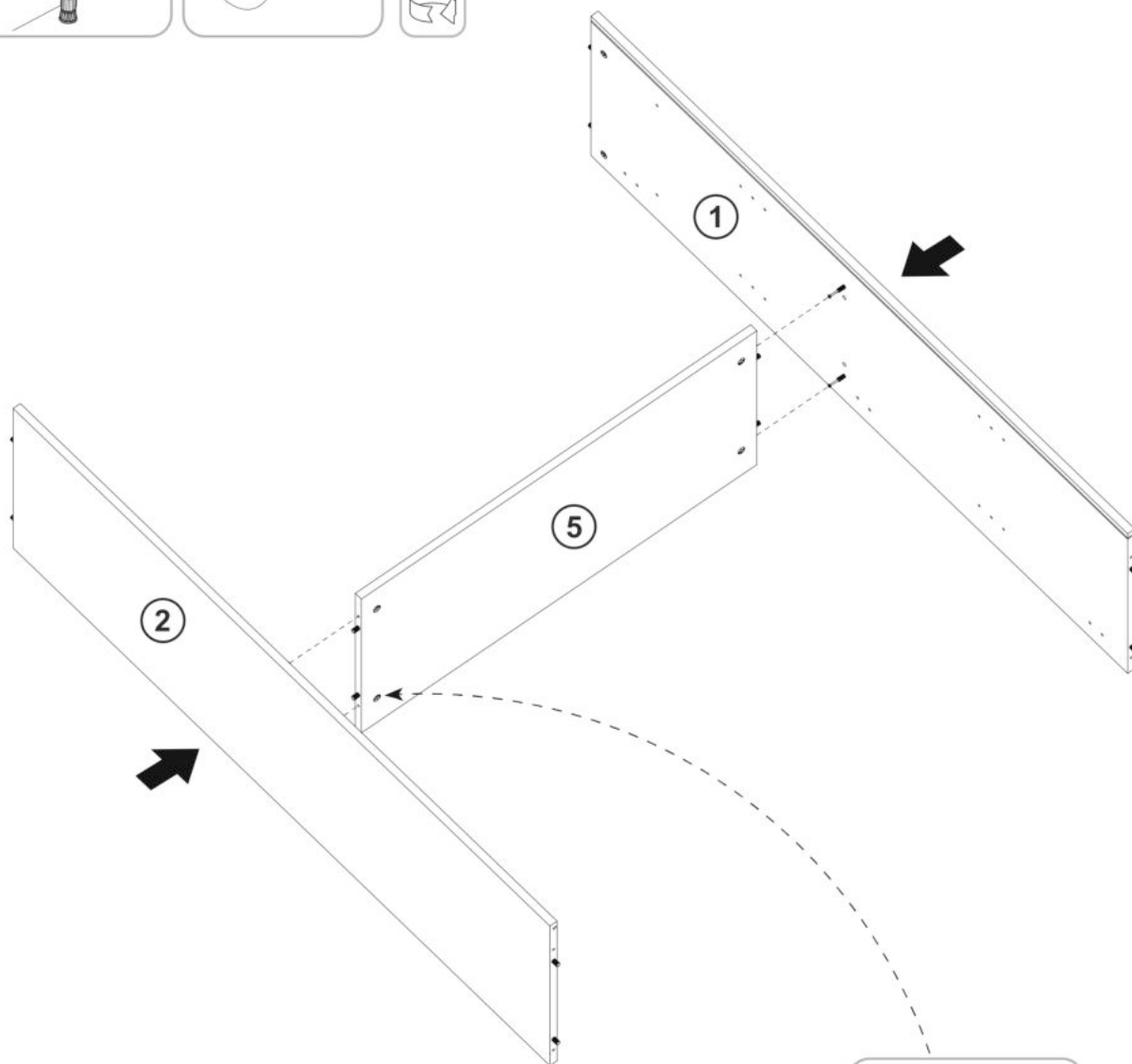
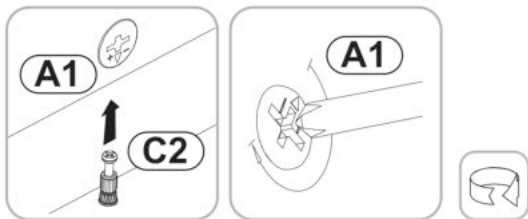

5

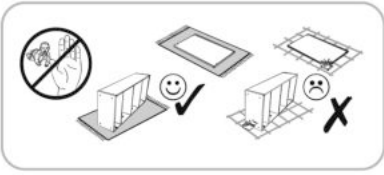

O4
Ø18 x4

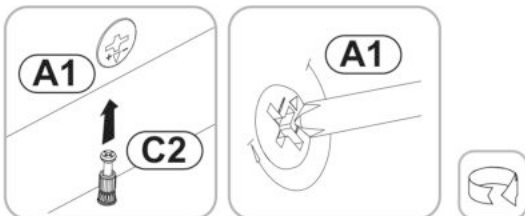
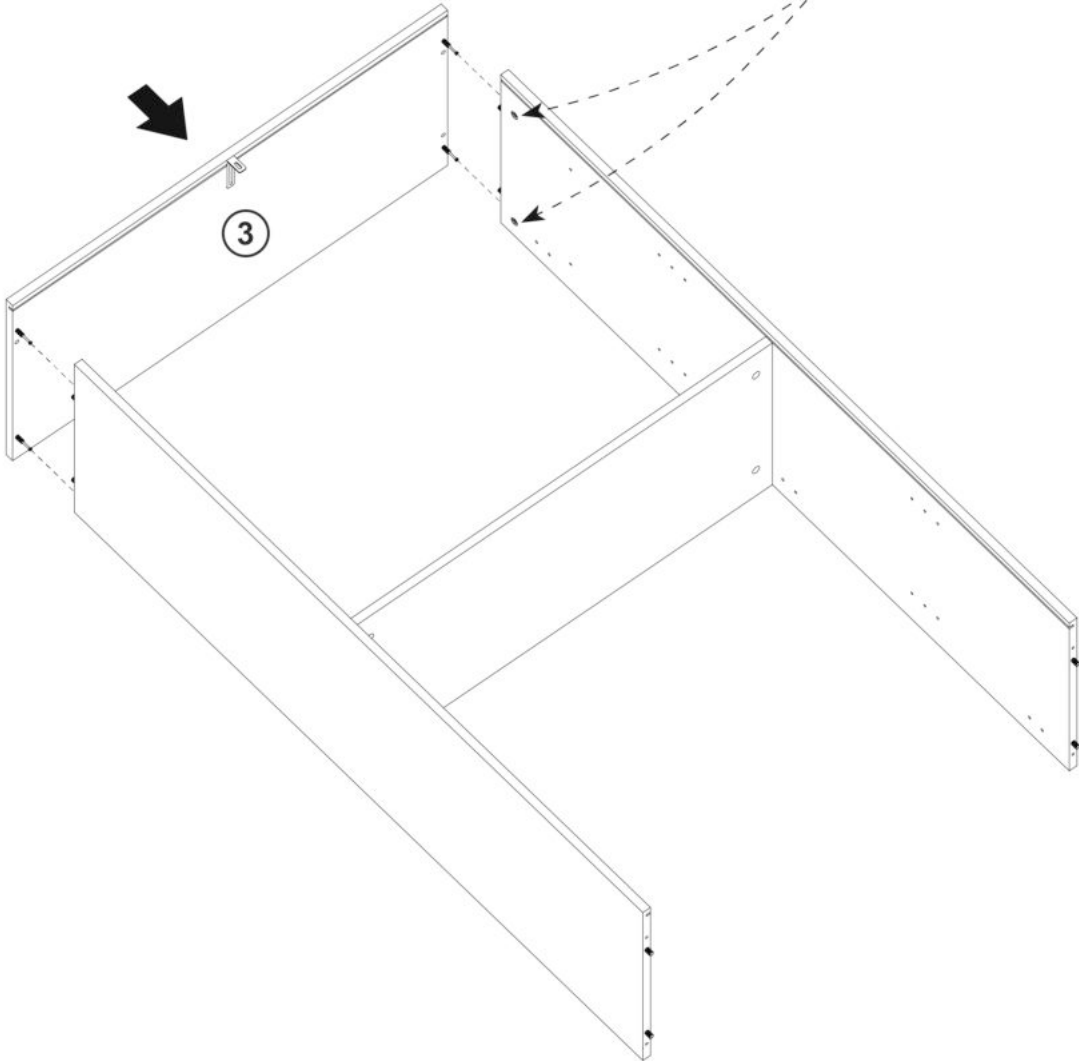
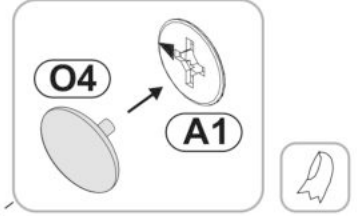

6

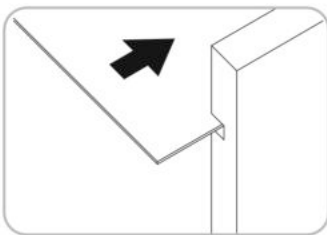
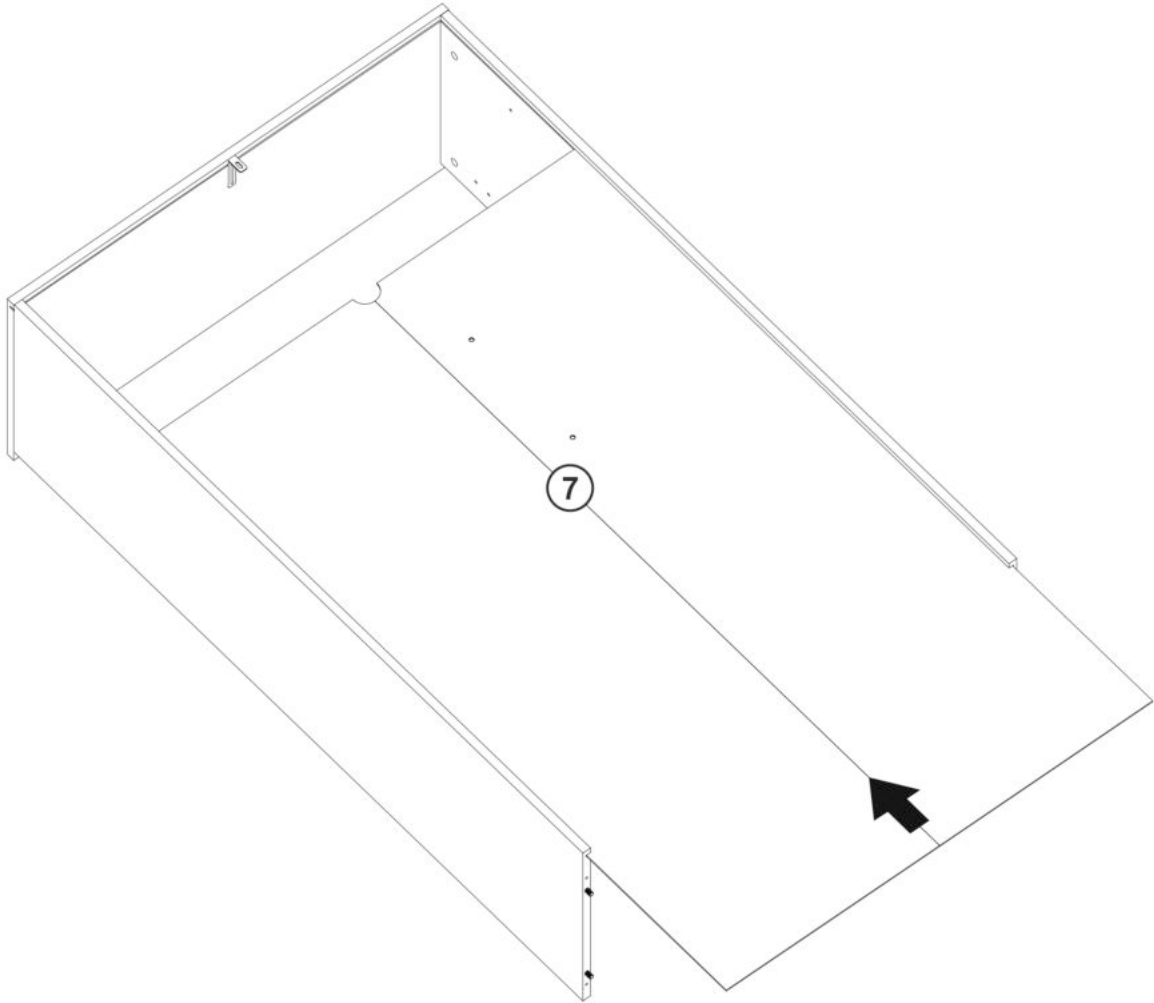
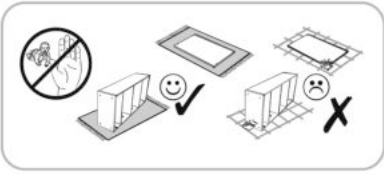

7

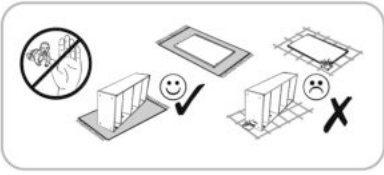

FA1
4mm x1

F3
6,3x50 x4

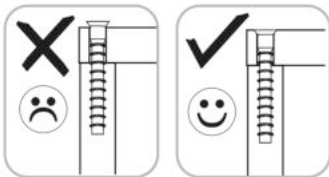
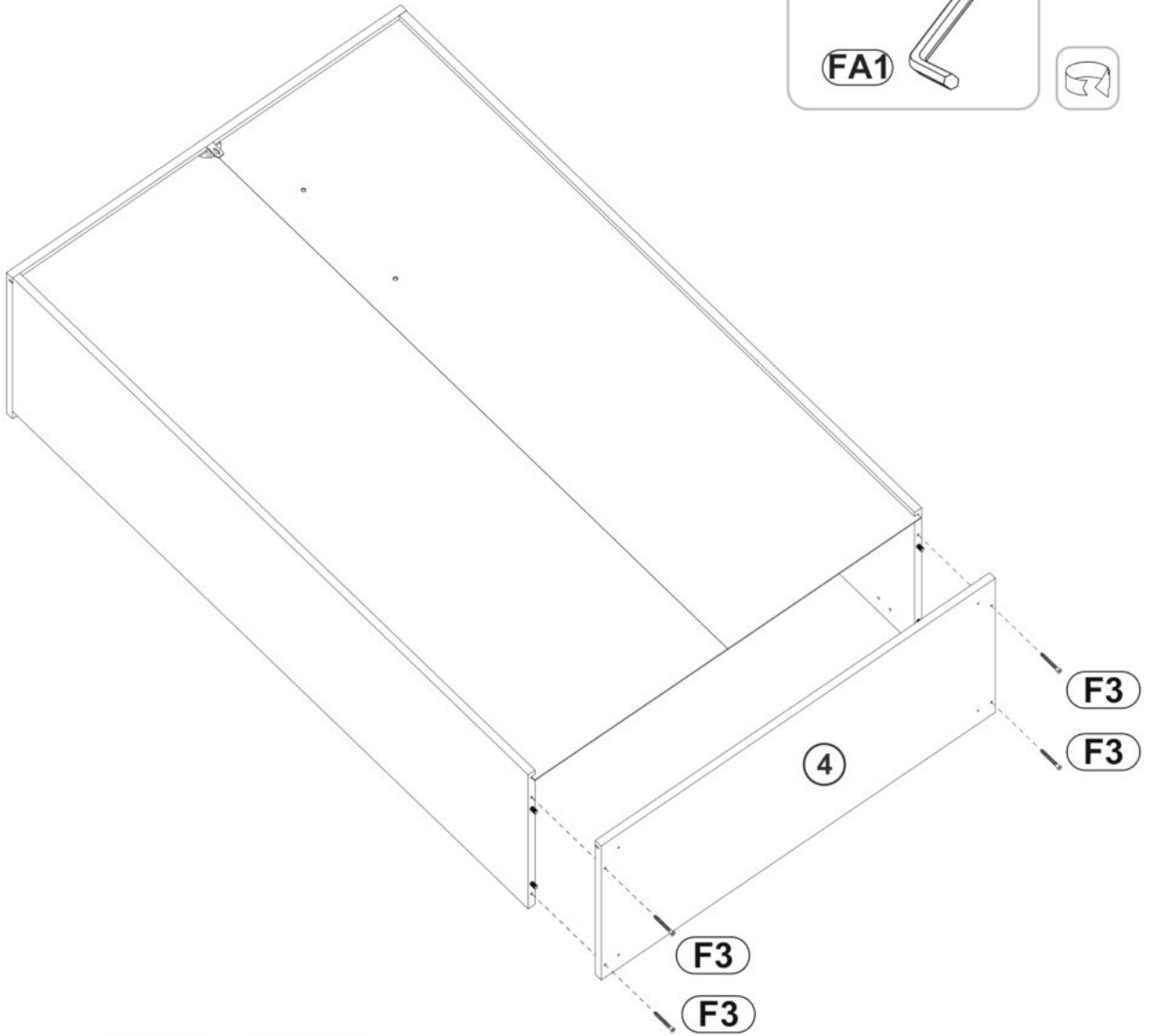
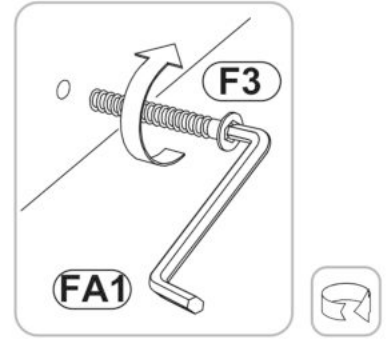

8

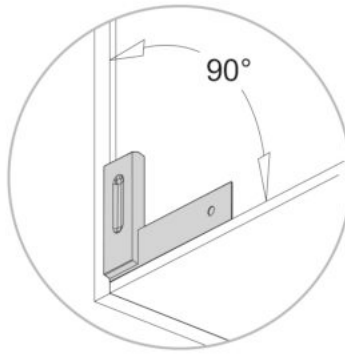
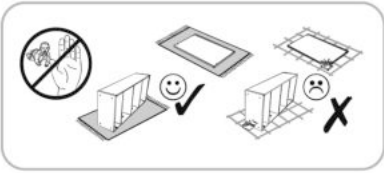

A=B

M1
10x10x15 x12

DA21
4,2x16 x2

P14
45x20 x4

D25
4x25 x4

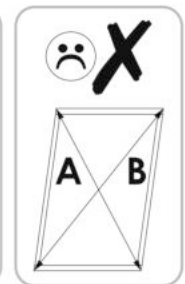
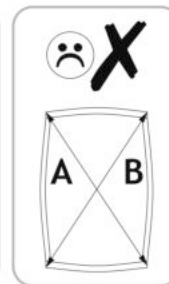
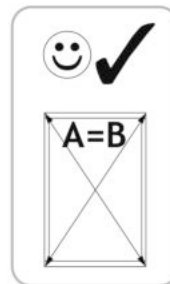
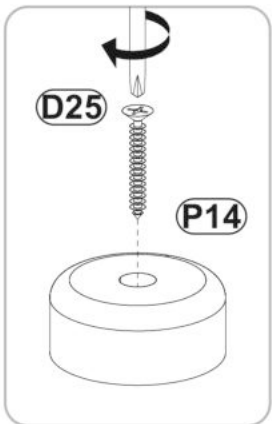
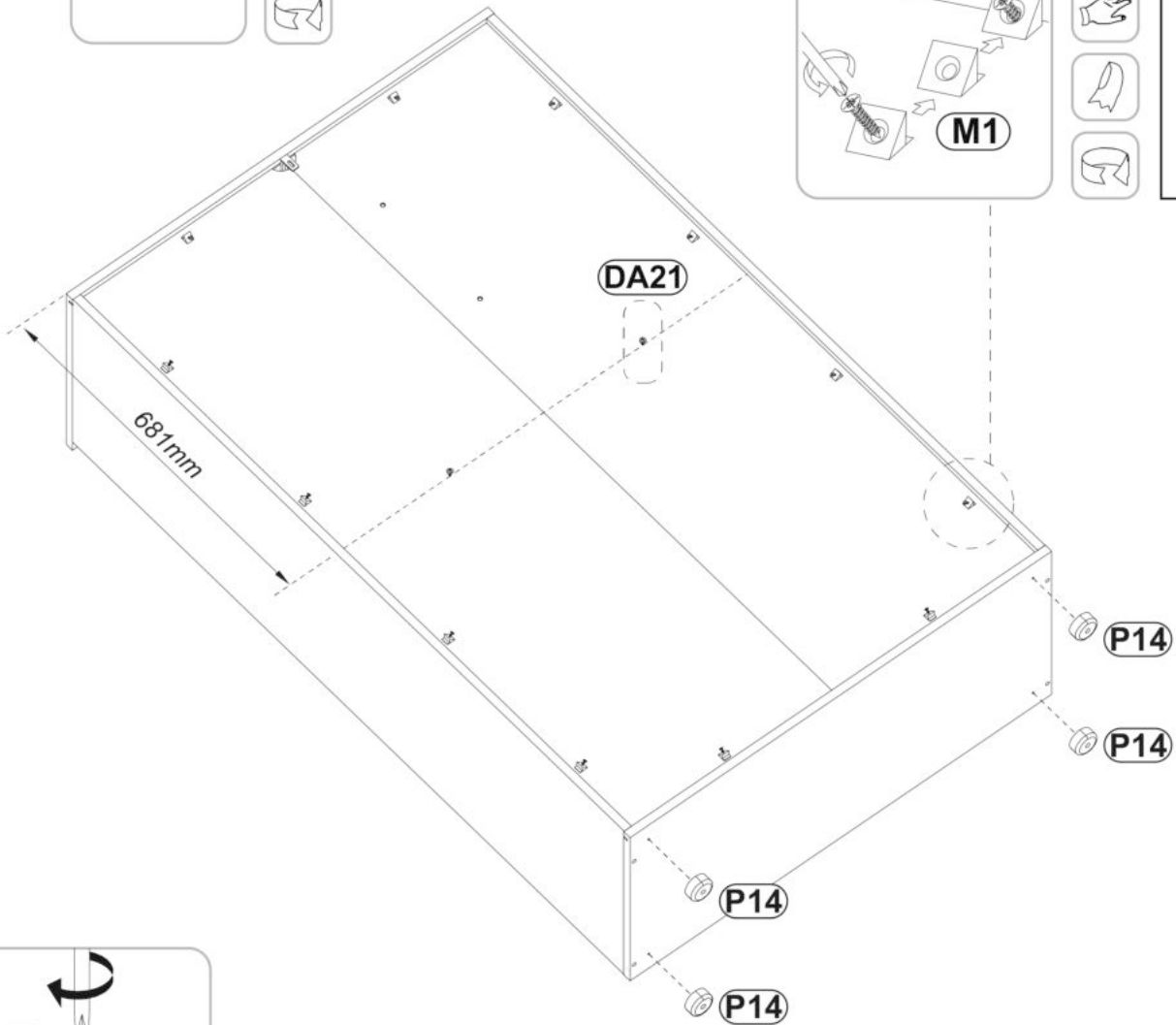
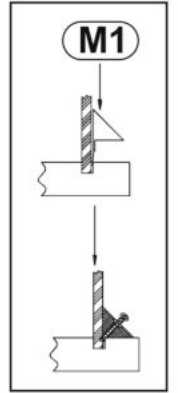
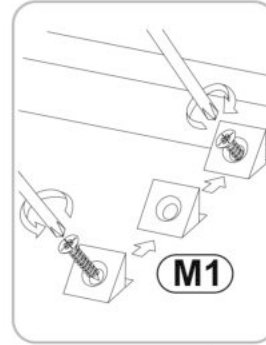
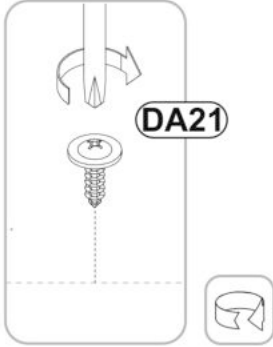

9

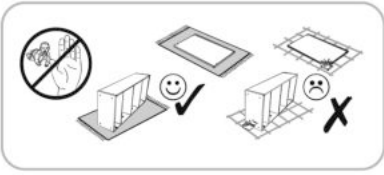

N1  **x12**
Ø6

O5  **x2**
Ø8

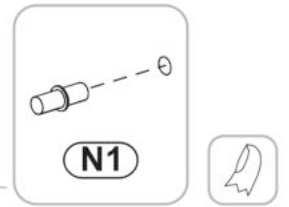
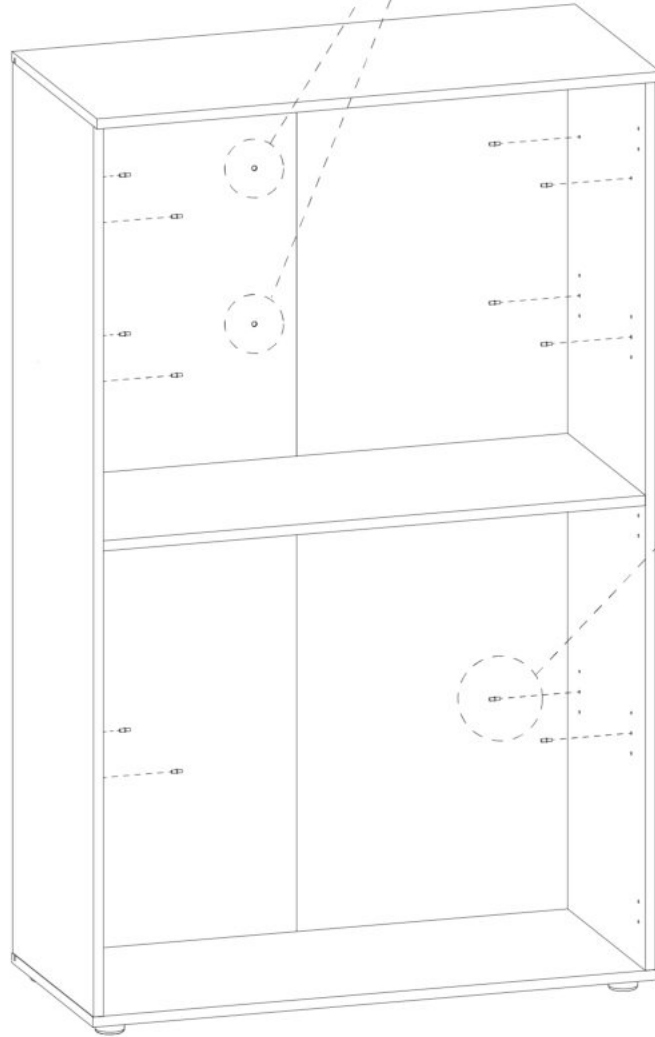
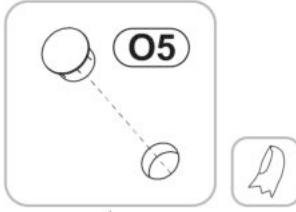

10

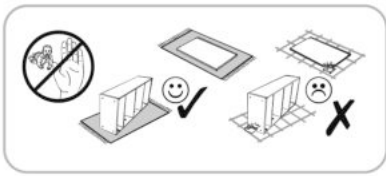

Y37
8x50 x1

Y35
4,2x65 x1

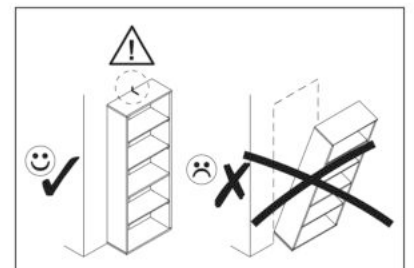
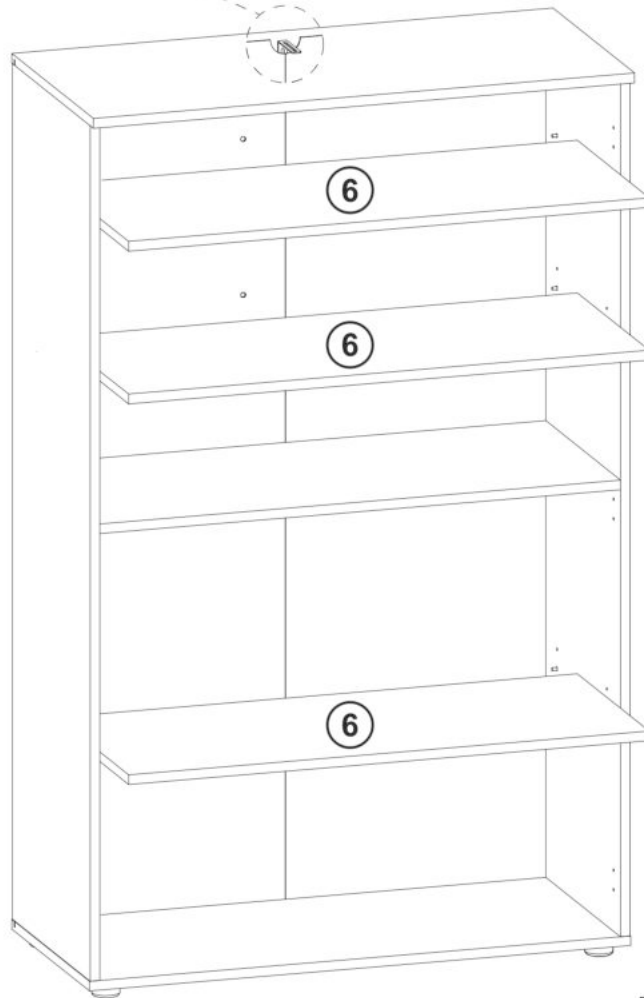
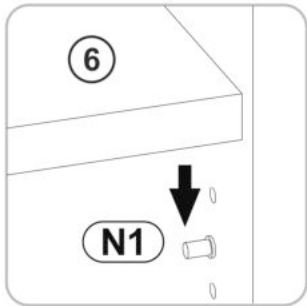
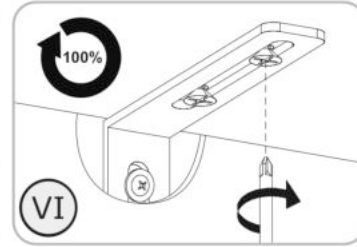
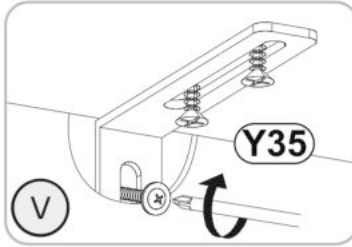
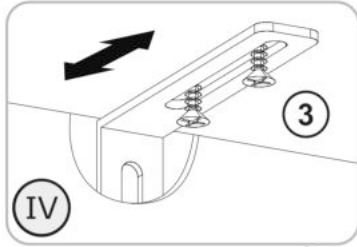
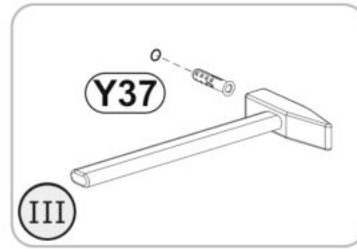
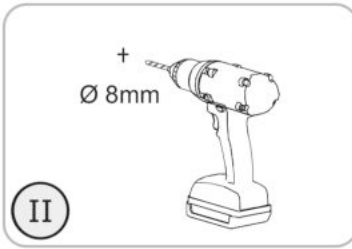
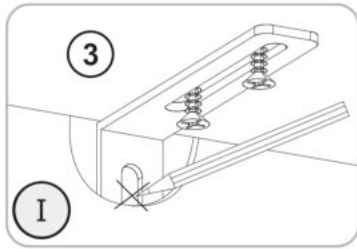

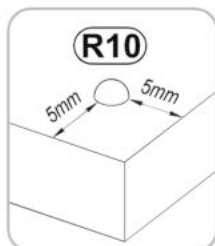
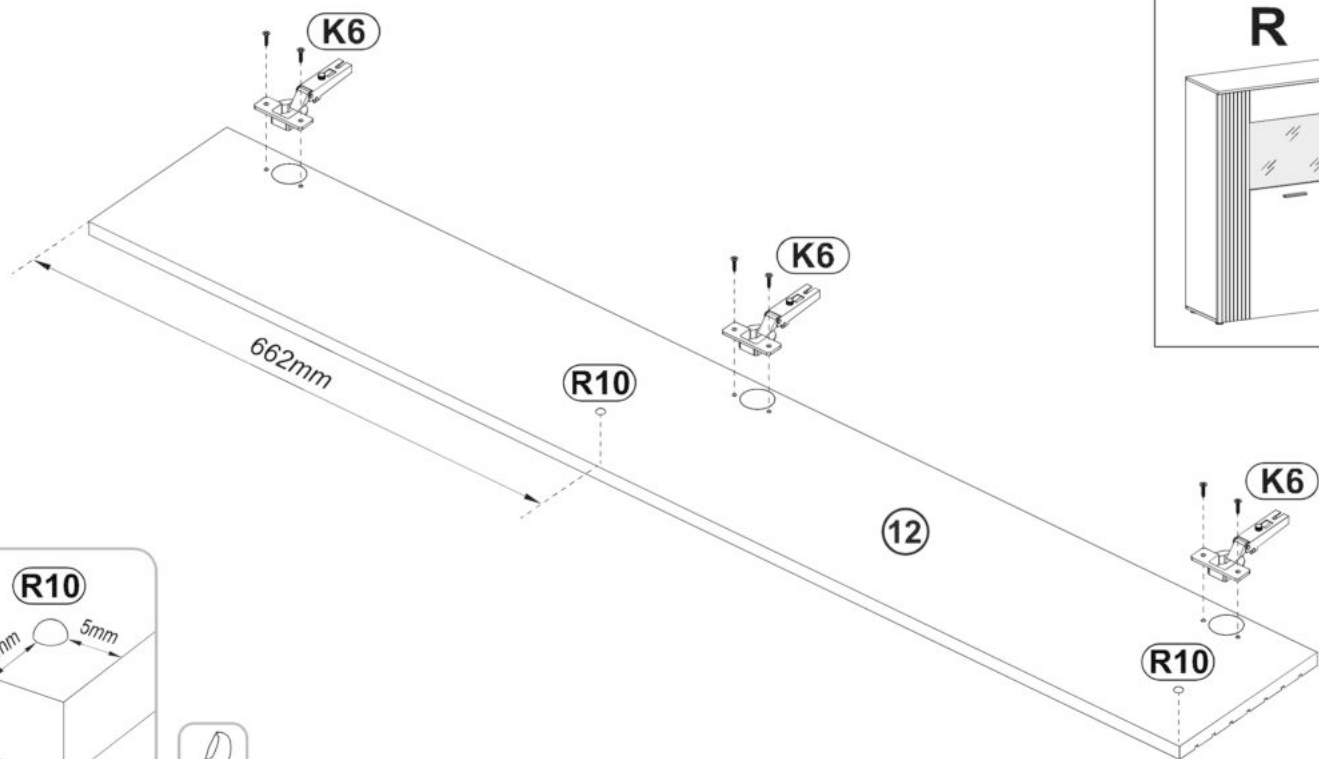
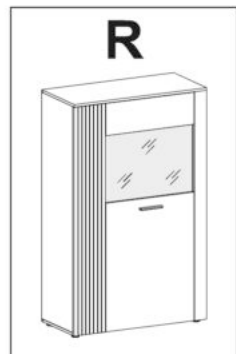
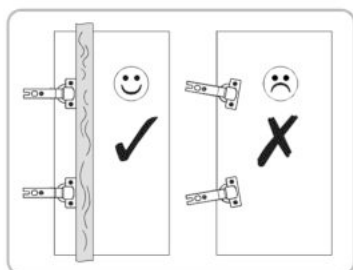
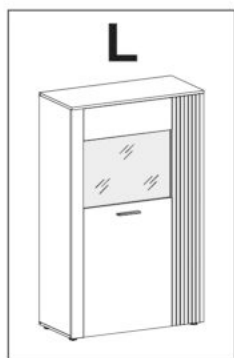
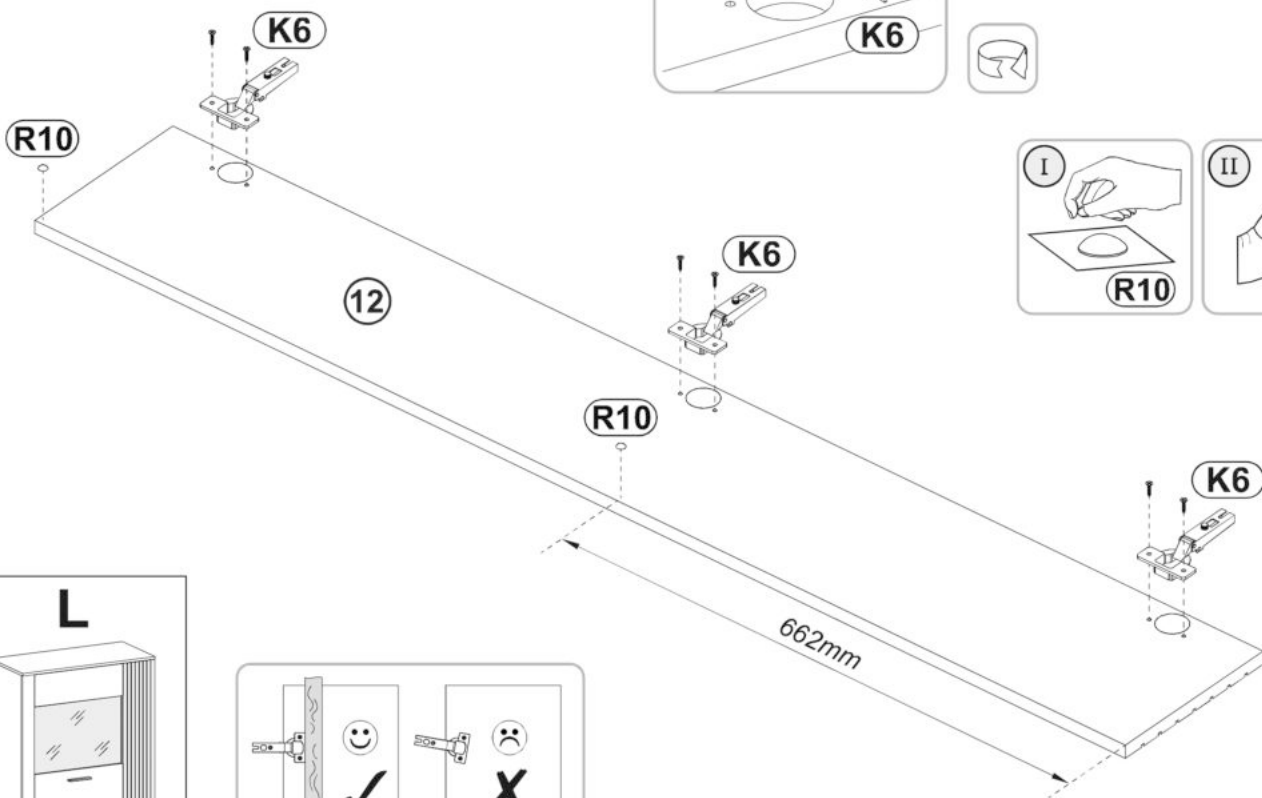
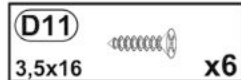
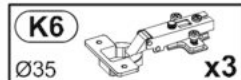
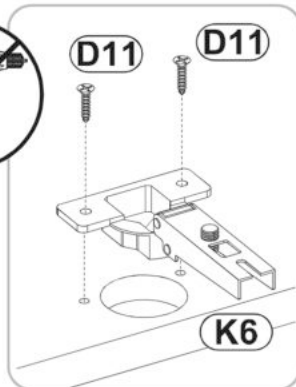
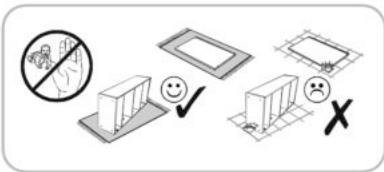

12

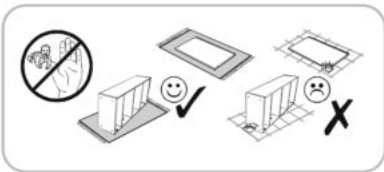

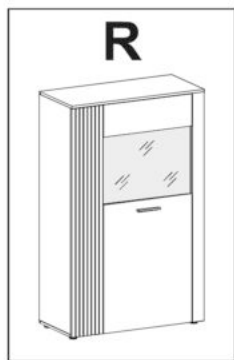
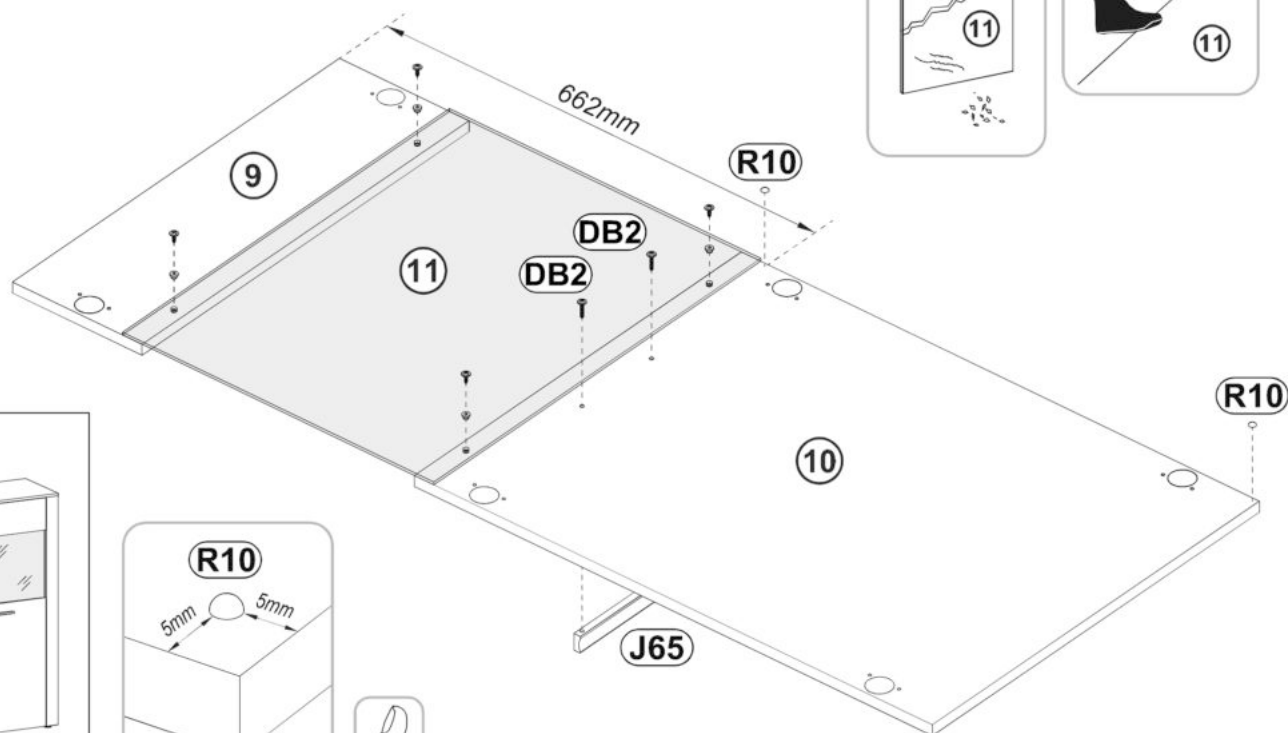
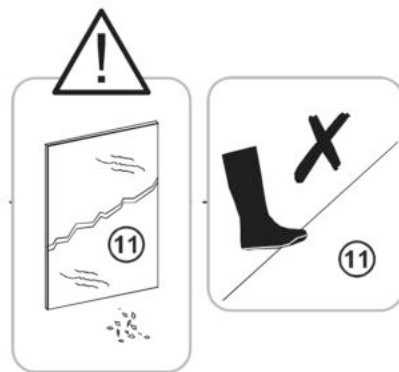
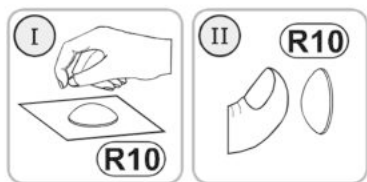
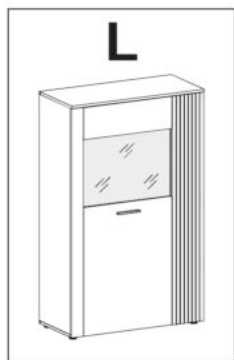
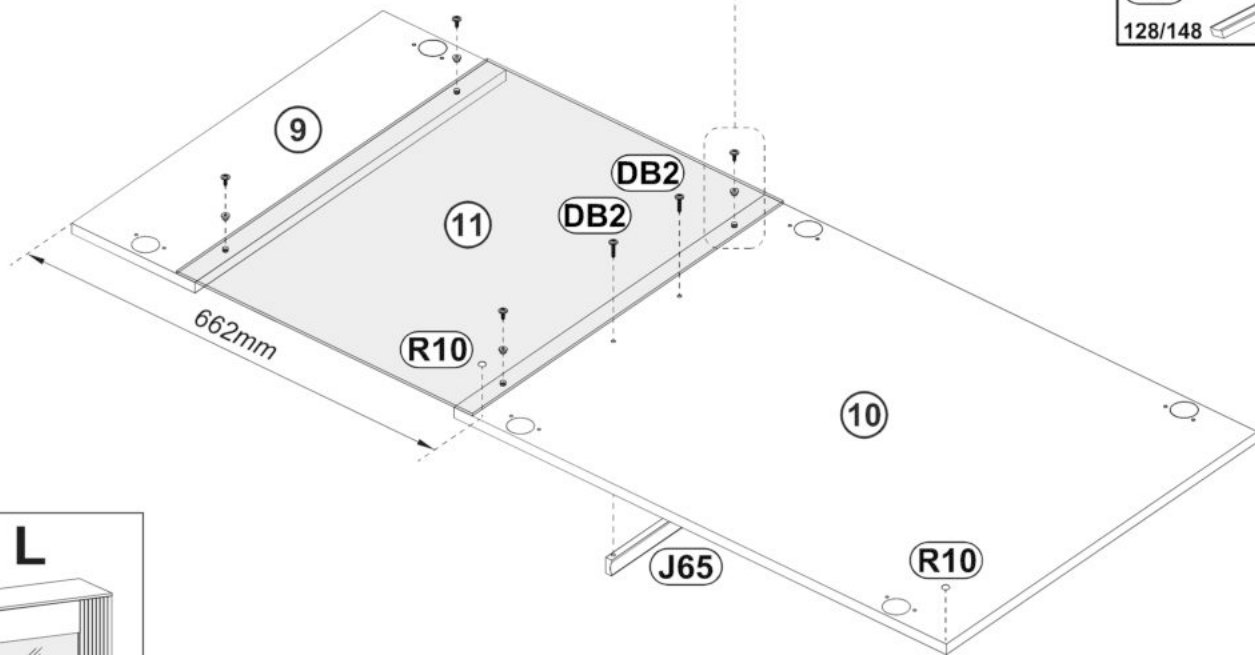

- N5**
10x6x10 x4
- DA21**
4,2x16 x4
- R10**
Ø10 x2
- DB2**
4x25 x2
- J65**
128/148 x1

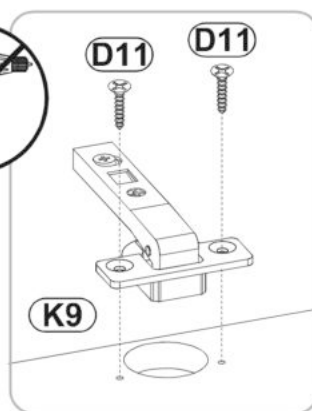
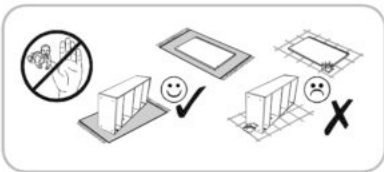

13



K9  x3
Ø35

D11  x6
3,5x16

O6  x3
40x40x14

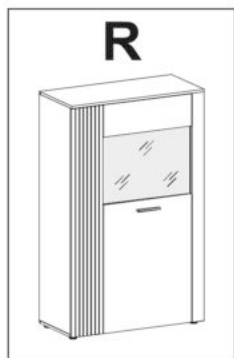
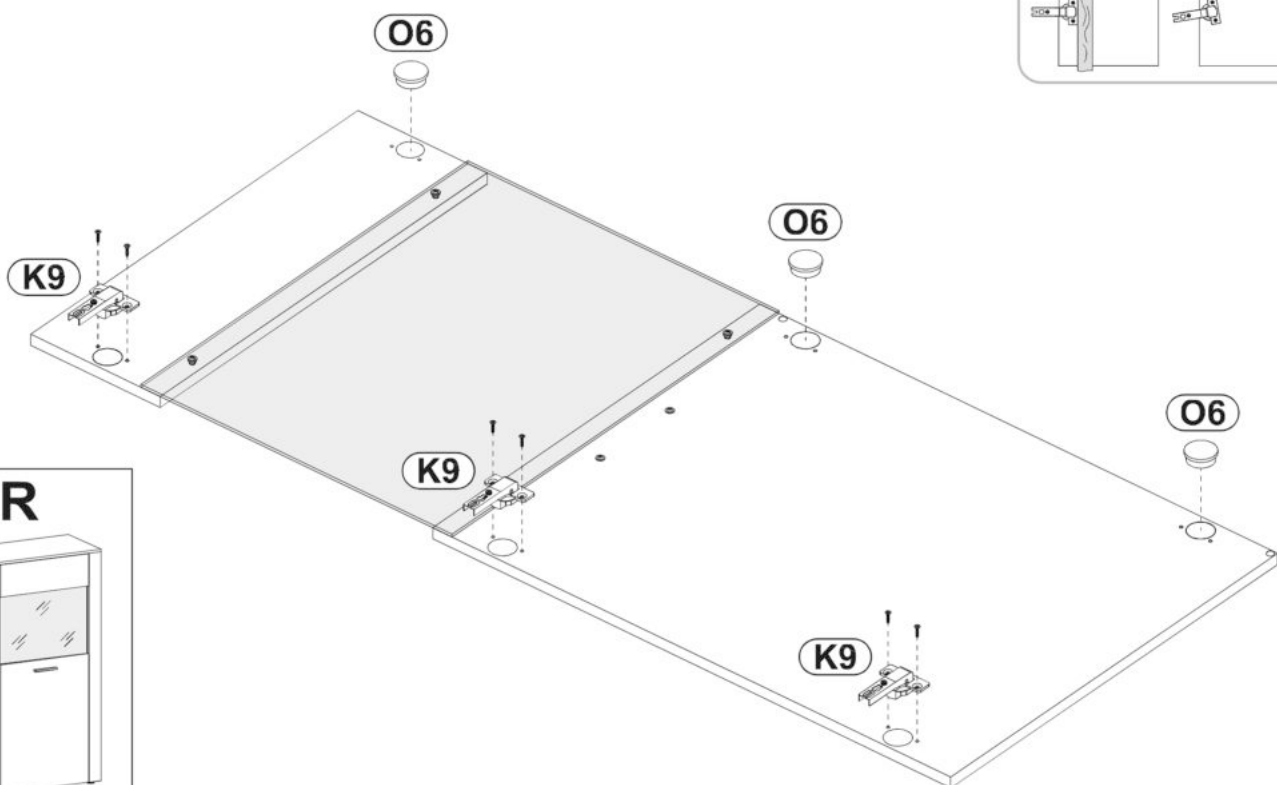
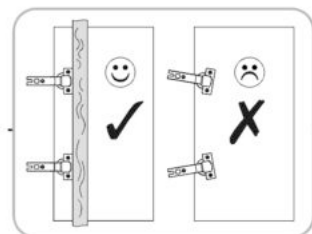
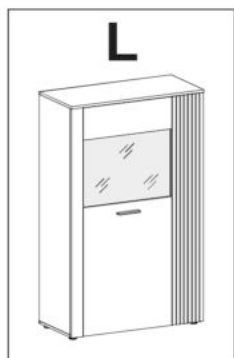
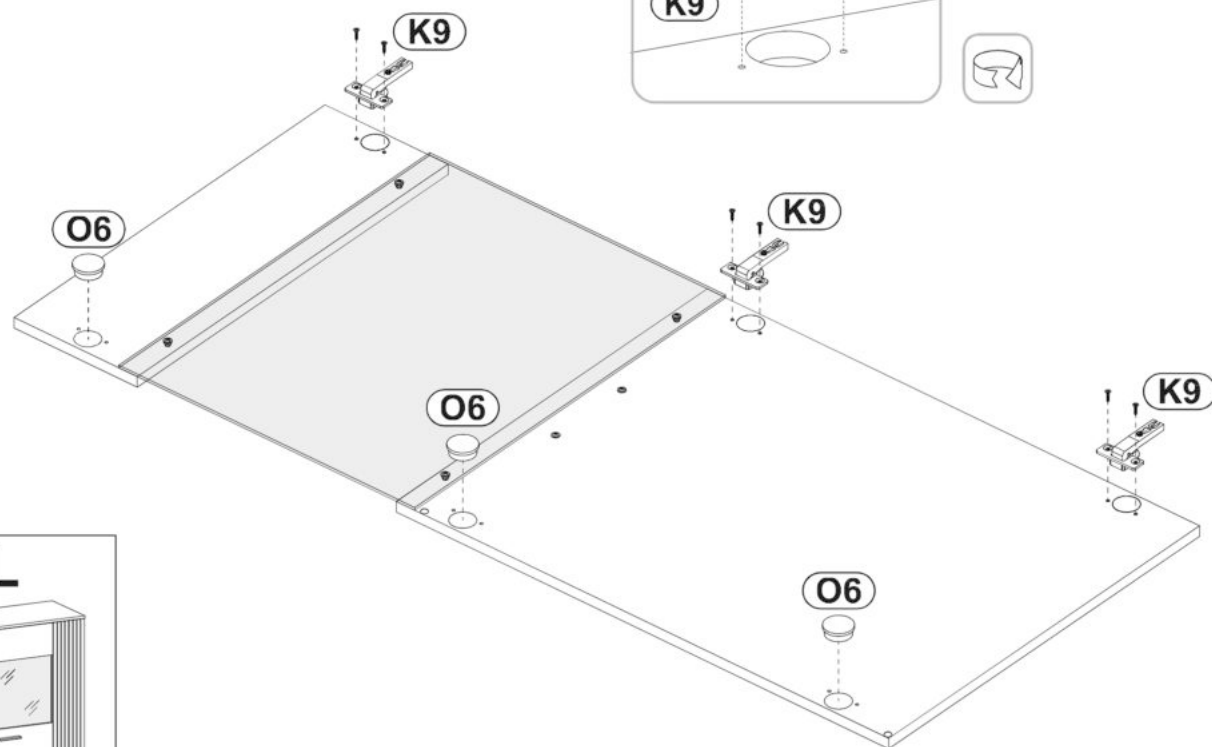

14

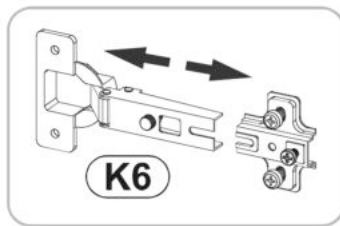
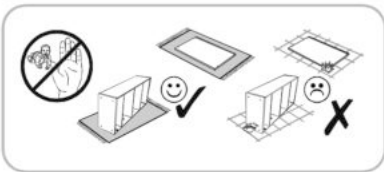

K6
Ø35  x3

DA21
4,2x16  x6

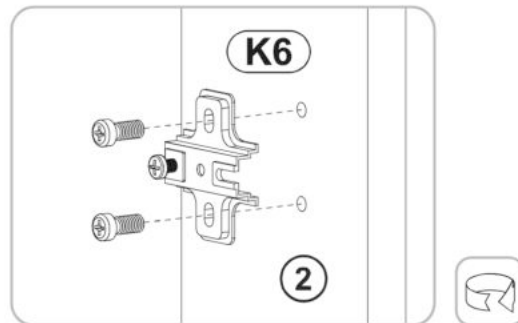
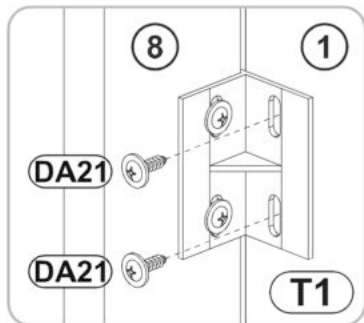
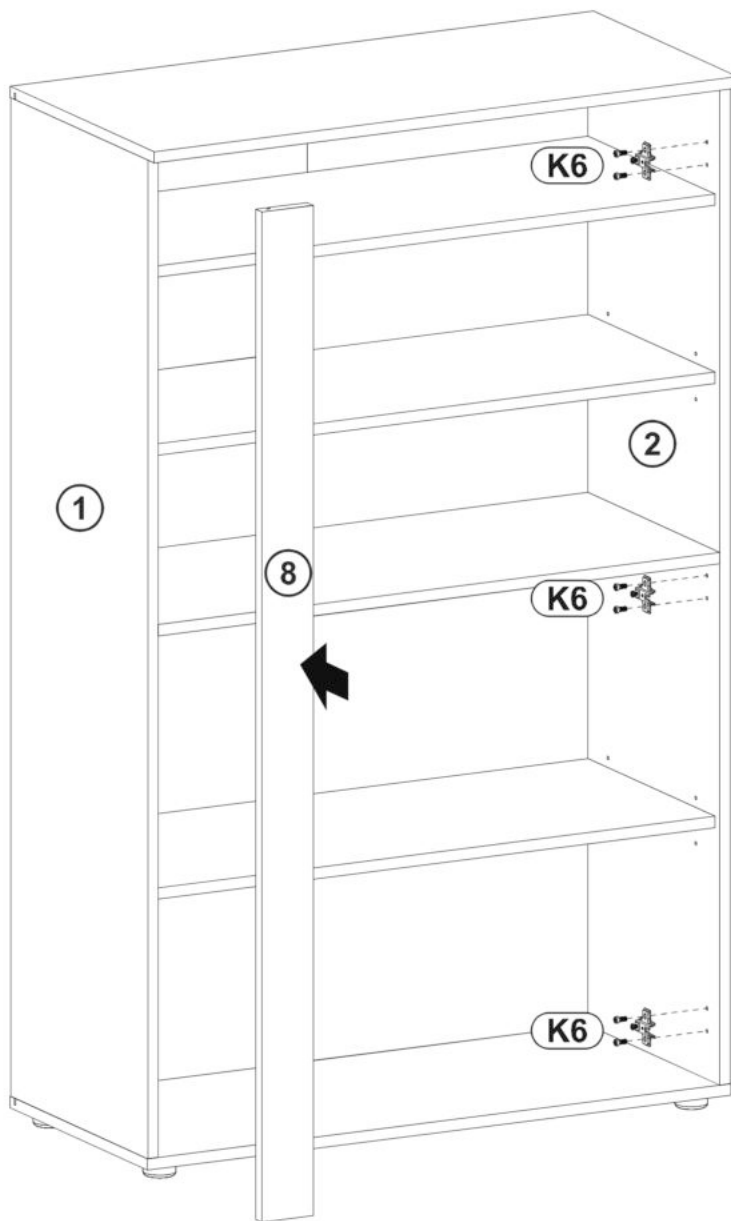
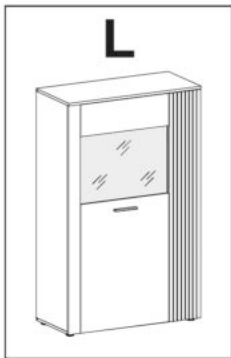

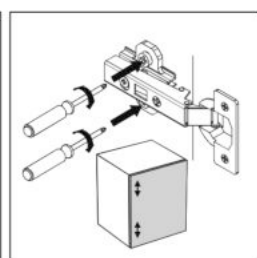
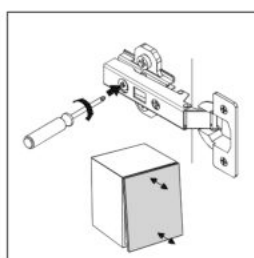
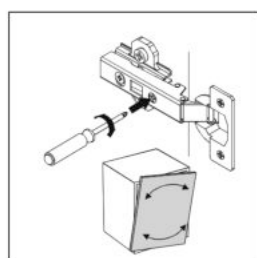
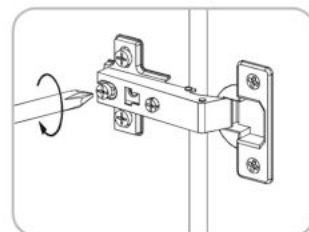
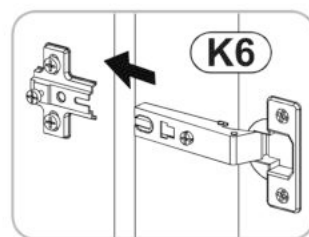
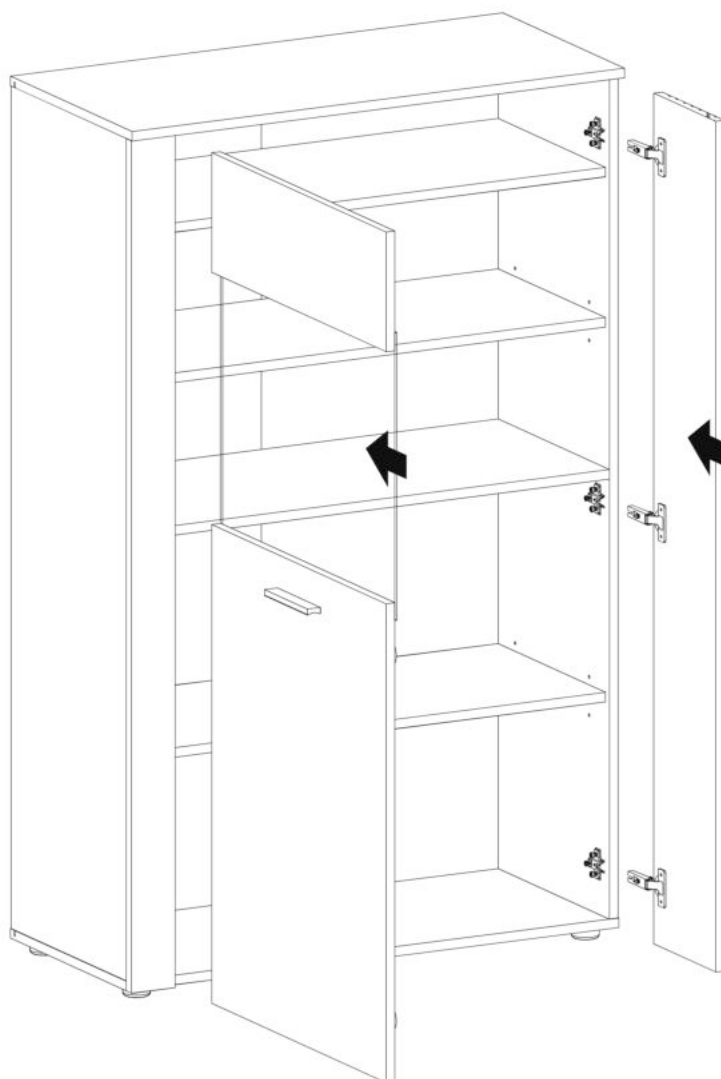
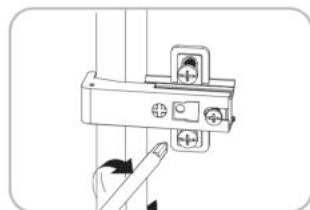
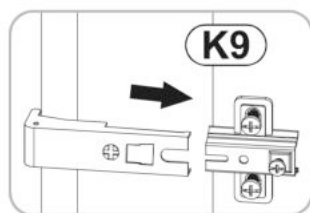
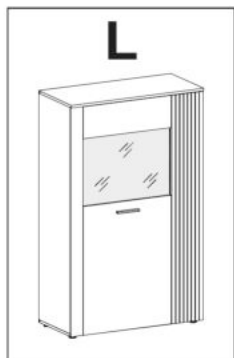
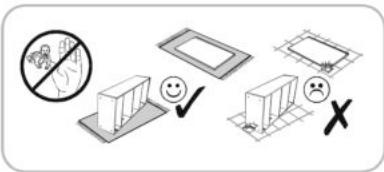

16

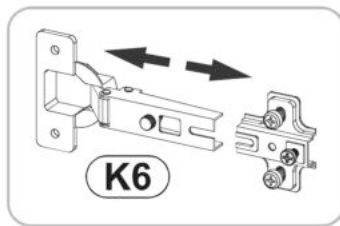
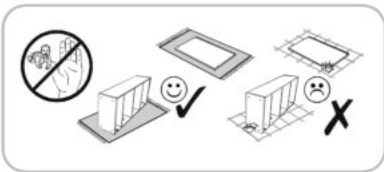

K6
Ø35  x3

DA21
4,2x16  x6

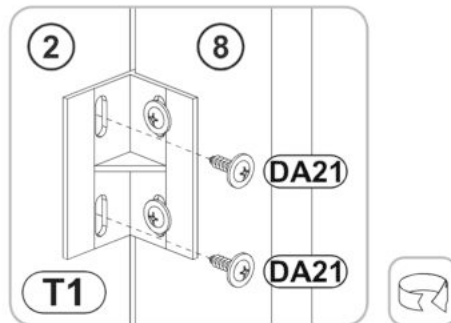
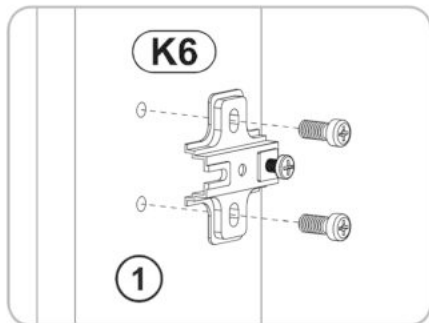
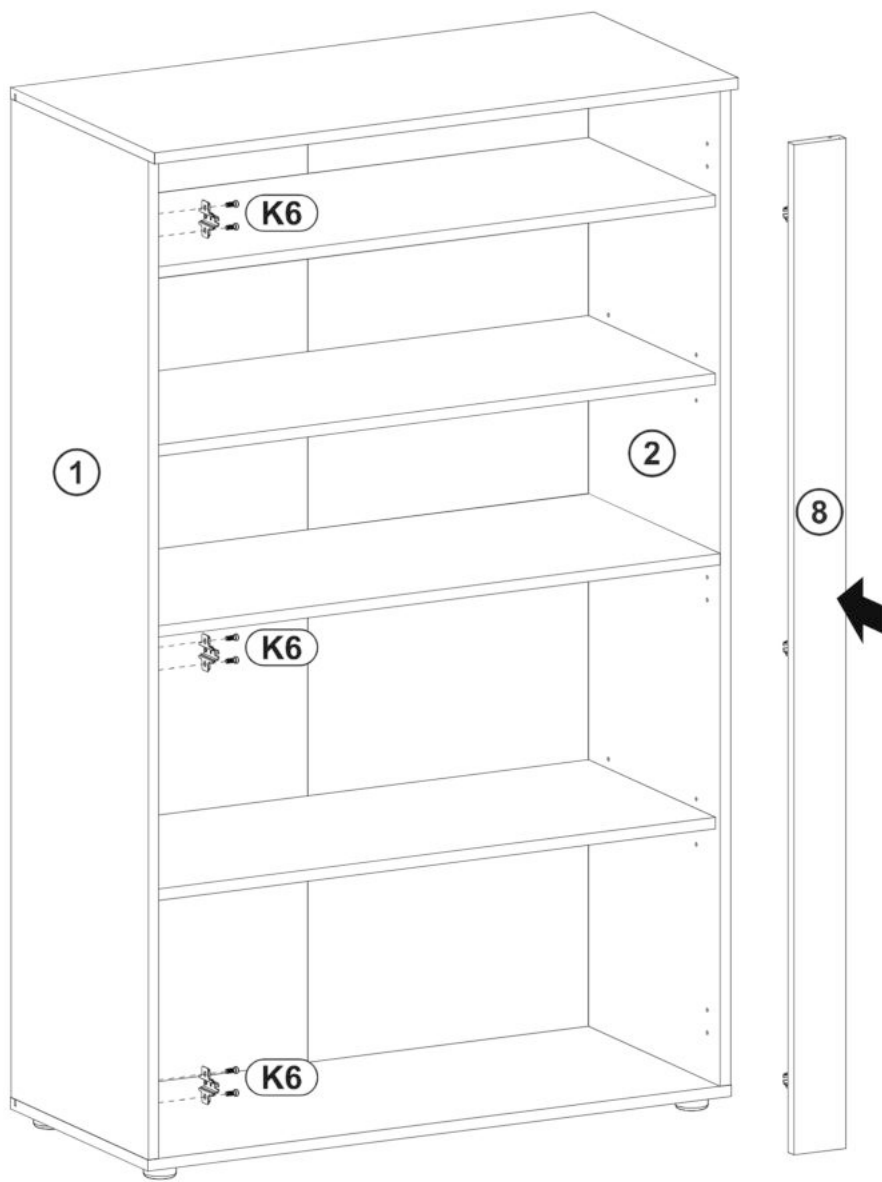
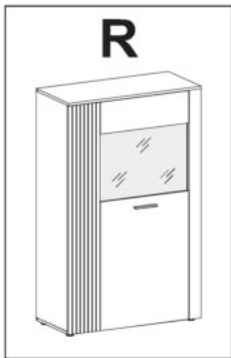

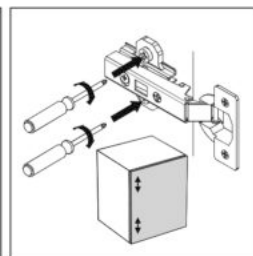
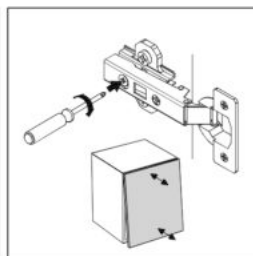
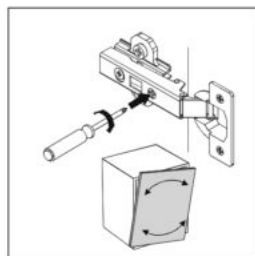
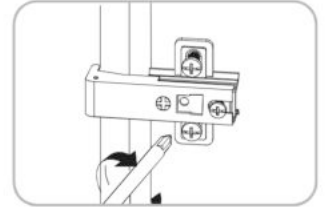
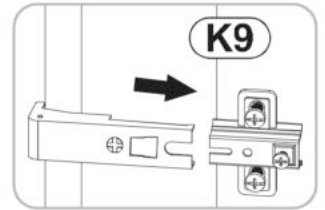
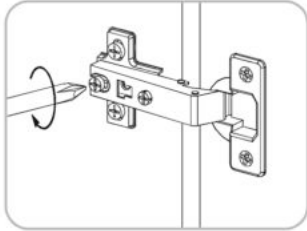
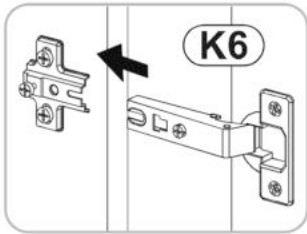
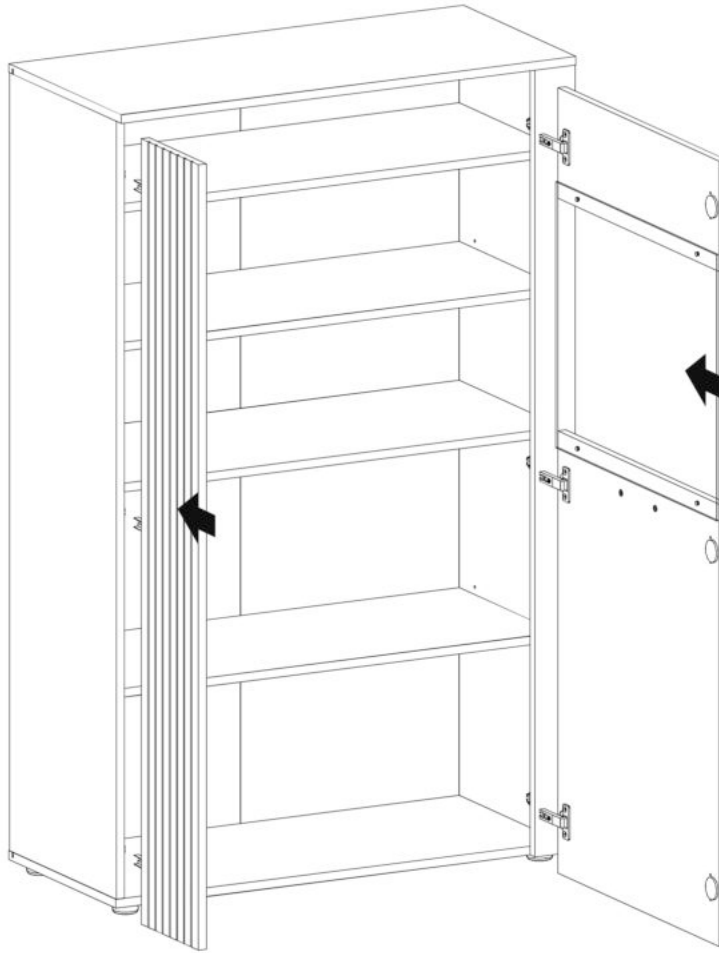
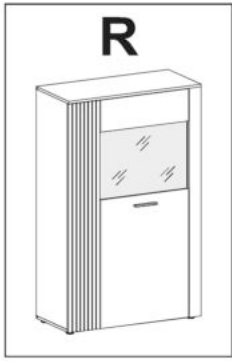
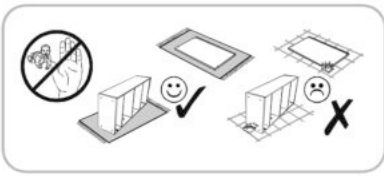



L

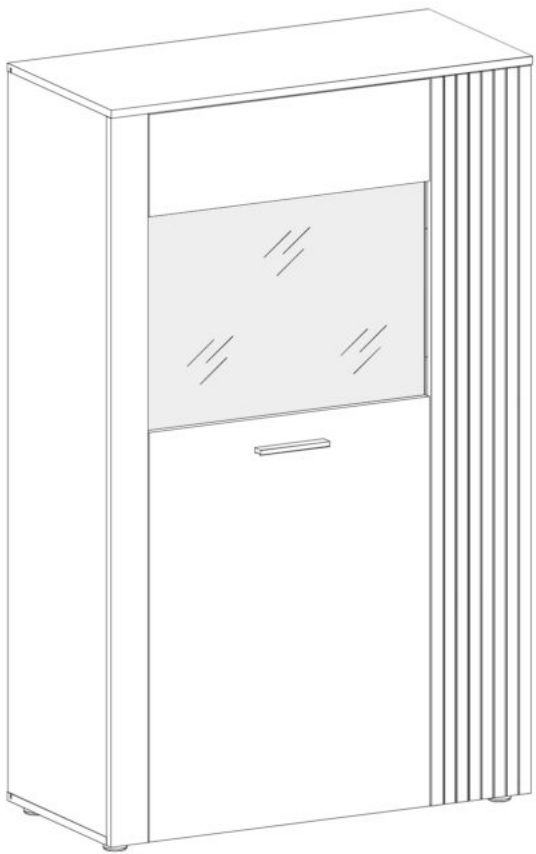

R

